



A.C.T. GmbH
Florian Volk
In den langen Lauben 2
64646 Heppenheim

Animations-Maschine LTD
24 Mesologgiou
CY-8873 Argaka, Paphos
info@animations-maschine.de
www.animations-maschine.com

14. September 2024

Storyboard Animationsvideo Kompostierung

Seite 1

Dieses Storyboard beschreibt den Ablauf und die Details vom späteren Animationsvideo. Dieses Storyboard dient als Grundlage der Animationserstellung. Sämtliche Bilder entsprechen bereits dem finalen Zustand und der finalen Optik. Farben, Materialien und Texturen sollten geprüft werden, da sie vor dem finalen Rendering noch problemlos geändert oder angepasst werden können.



Bild 1



Animations-Maschine LTD
24 Mesologgiou
CY-8873 Argaka, Paphos

info@animations-maschine.de
www.animations-maschine.de
VAT-ID: CY-10426974E

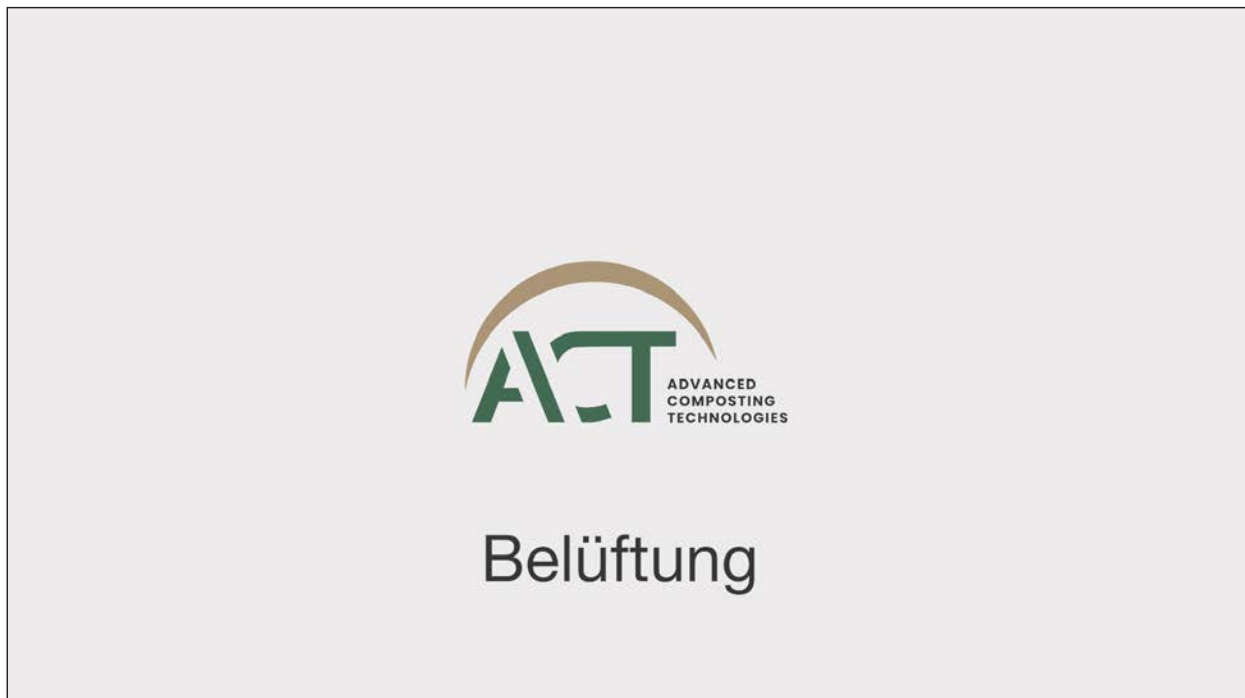
Managing Directors
Roland Walgenbach
Carmen Walgenbach

Bank: Hellenic Bank Cyprus
IBAN: CY42 0050 0502 0005 0201
BIC: HEBACY2N



Bild 2



Bild 3

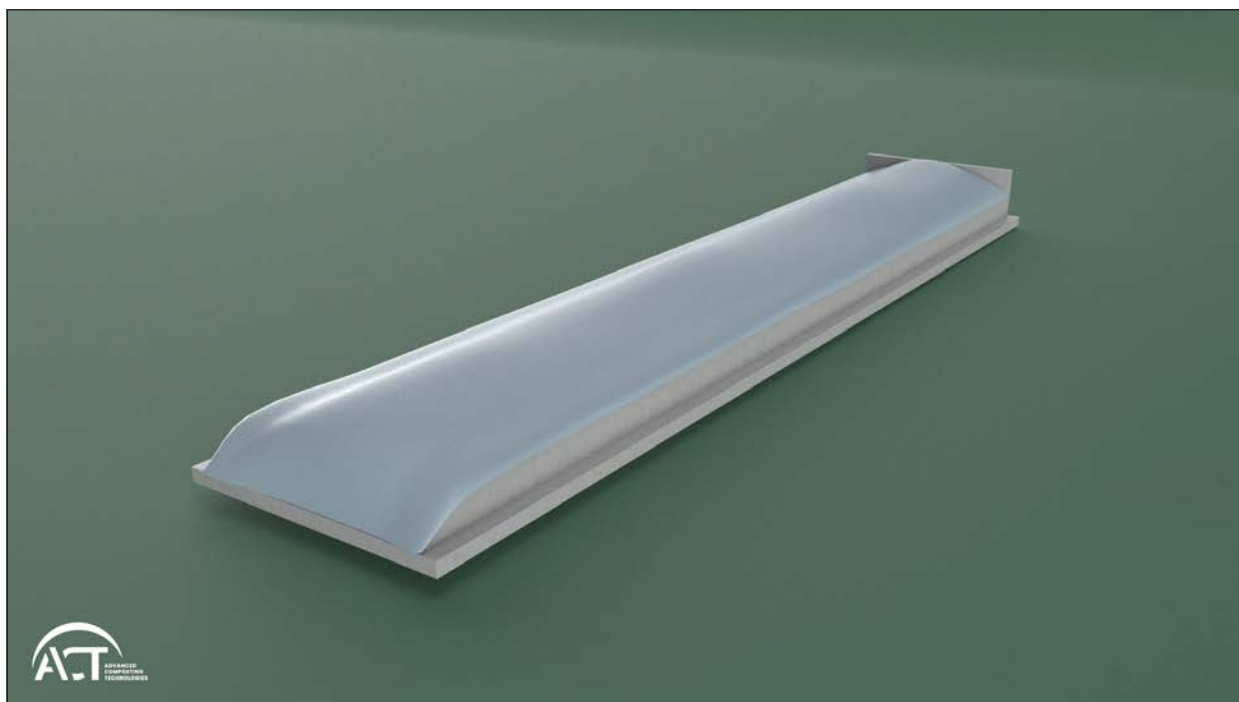

Bild 4

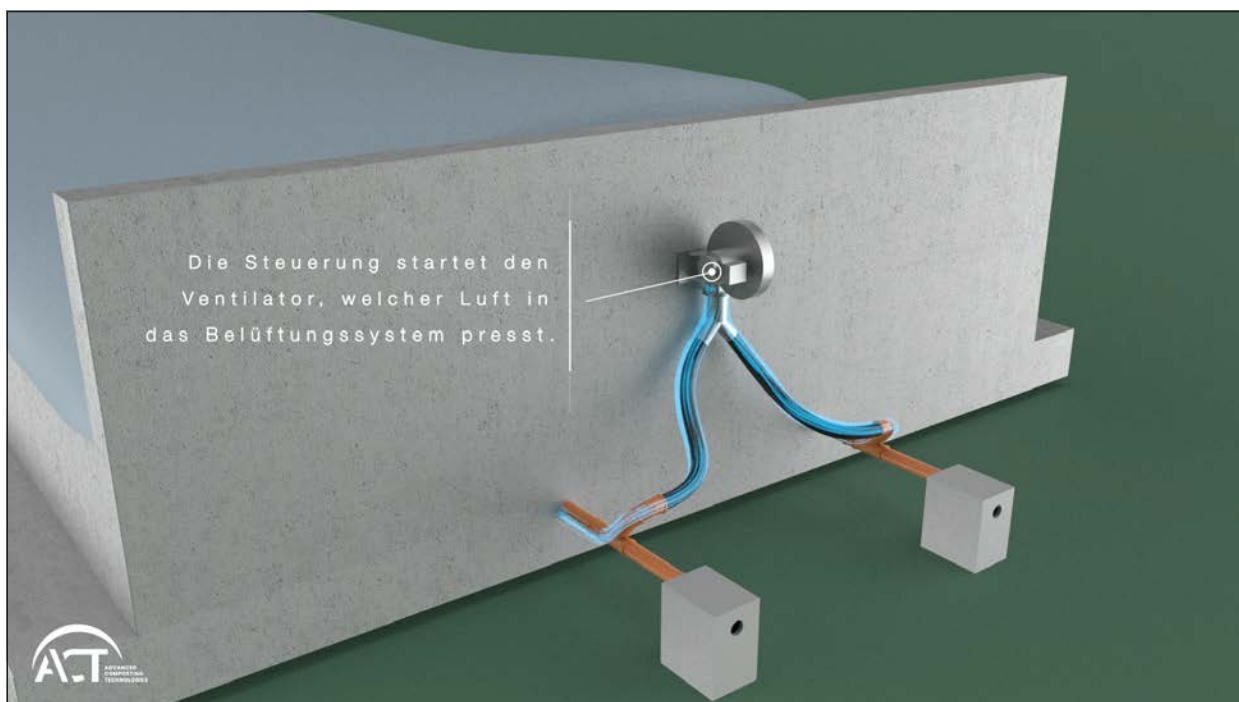

Bild 5

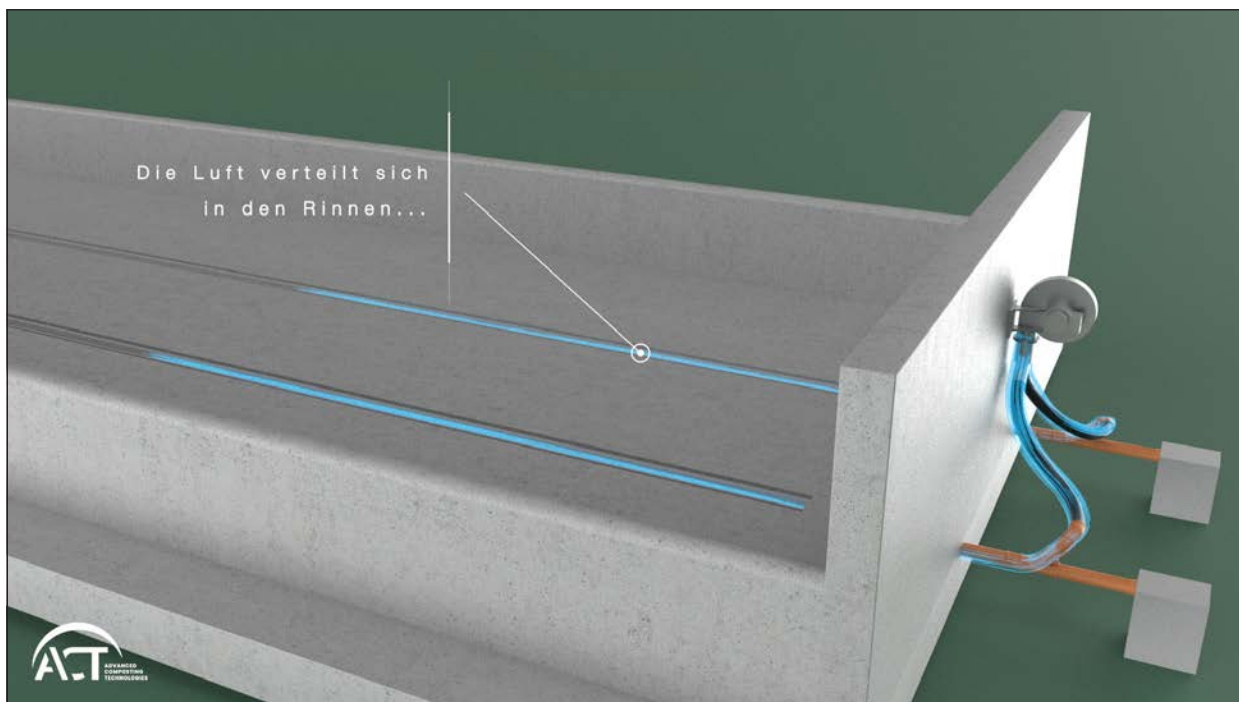

Bild 6

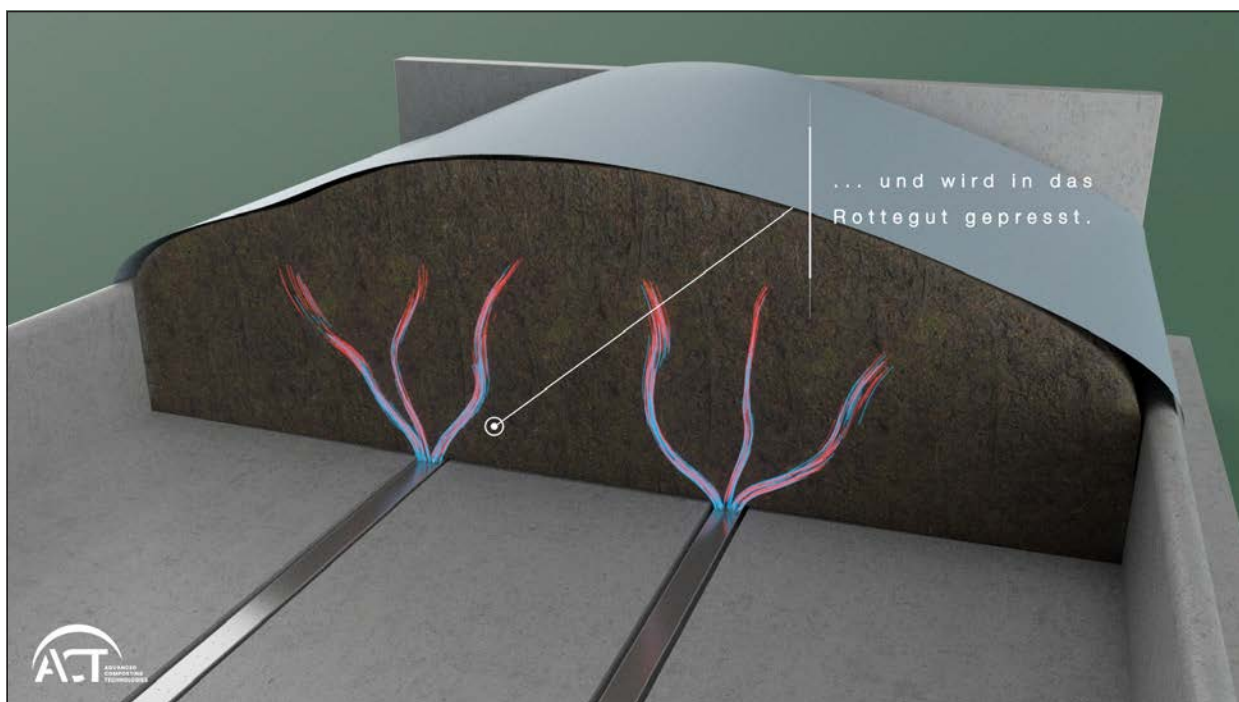

Bild 7

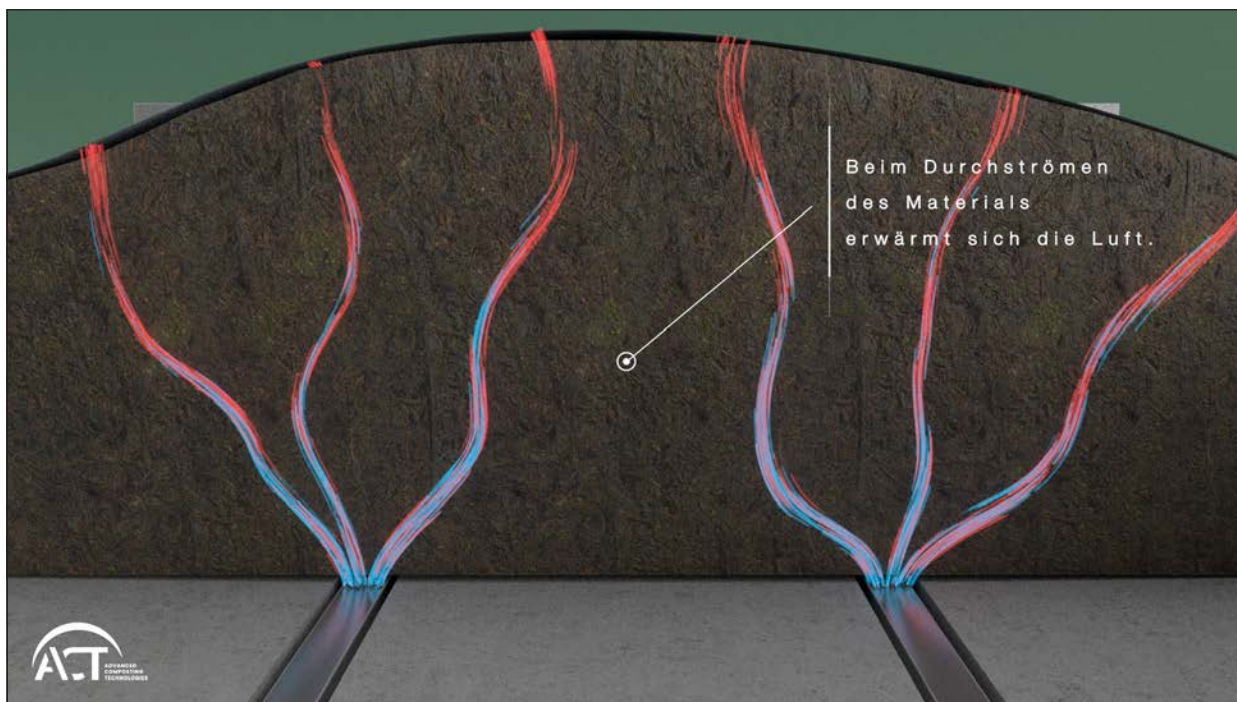

Bild 8

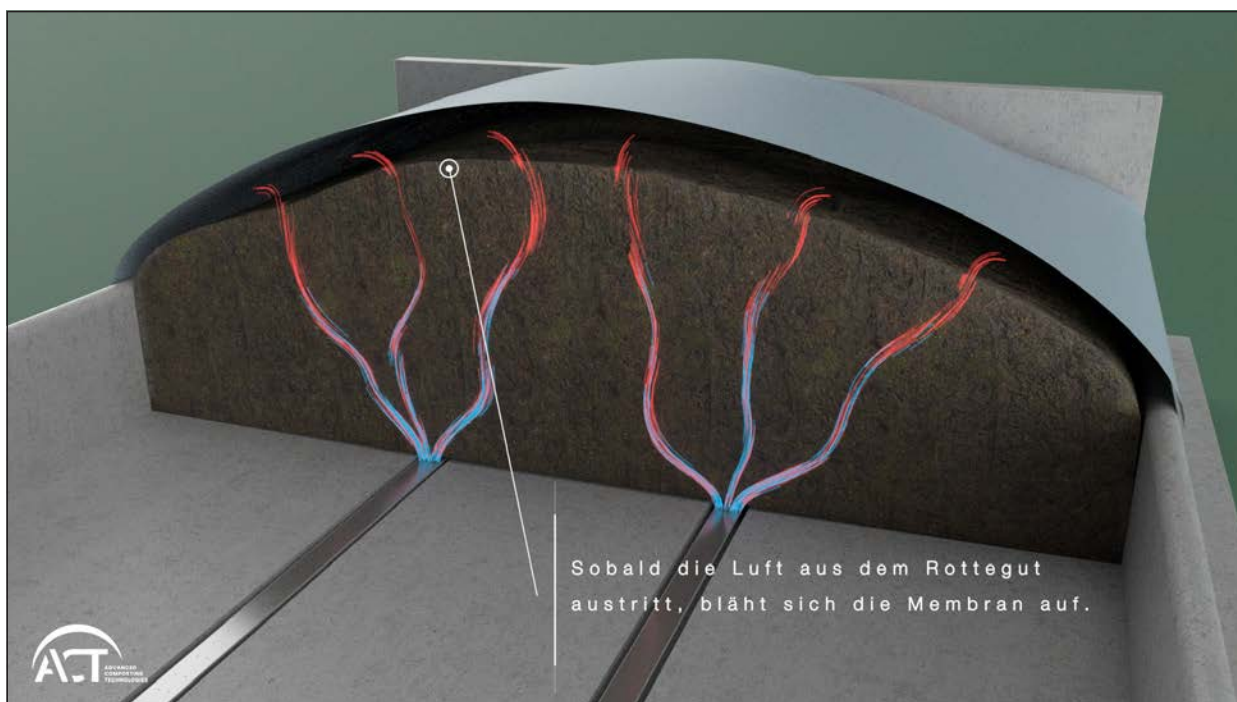

Bild 9

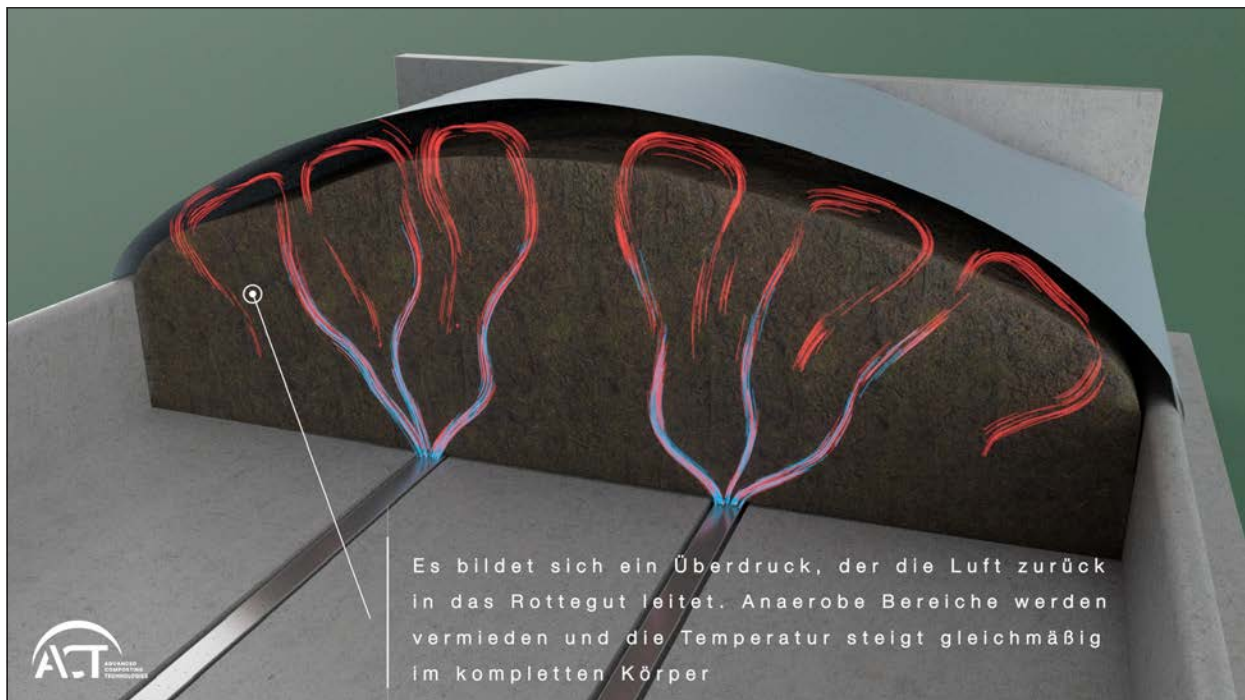

Bild 10

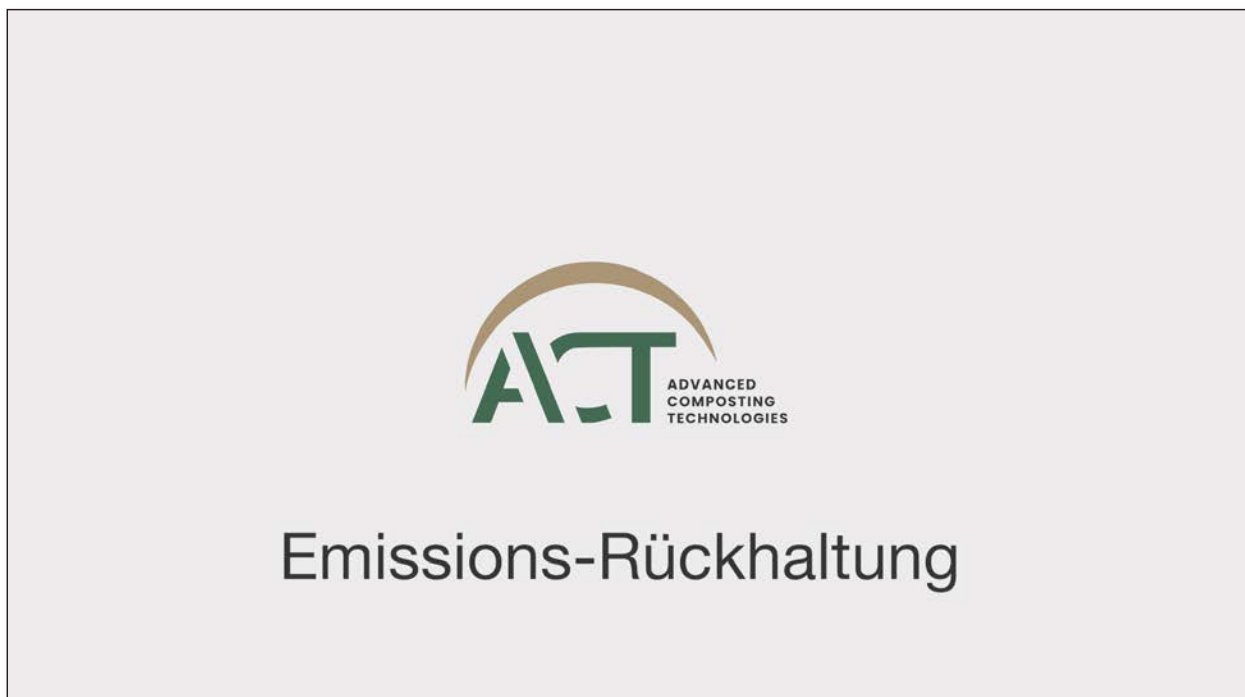

Bild 11



Bild 12

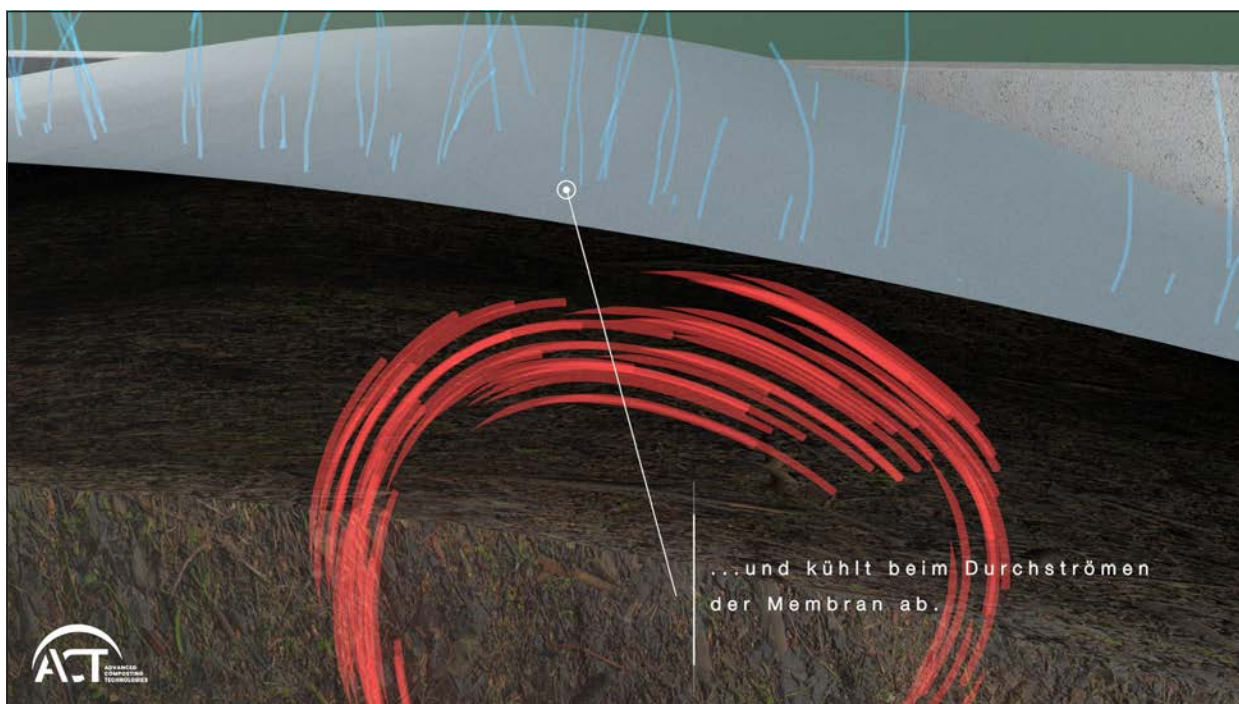

Bild 13

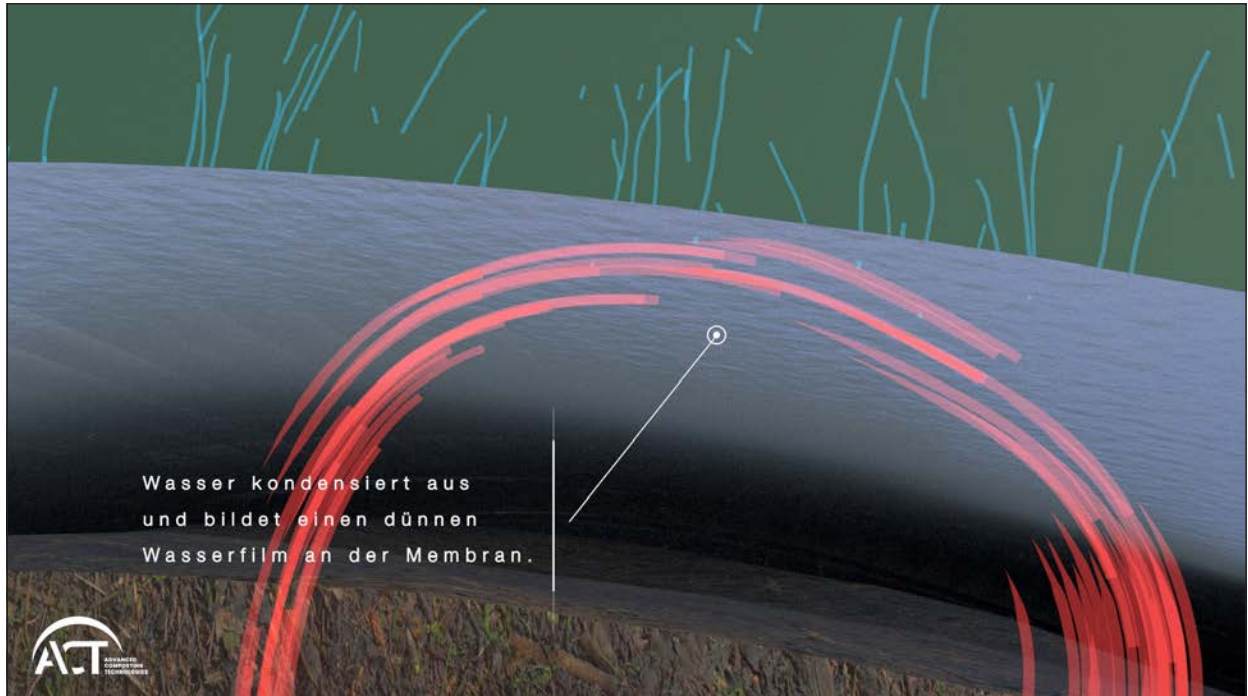

Bild 14

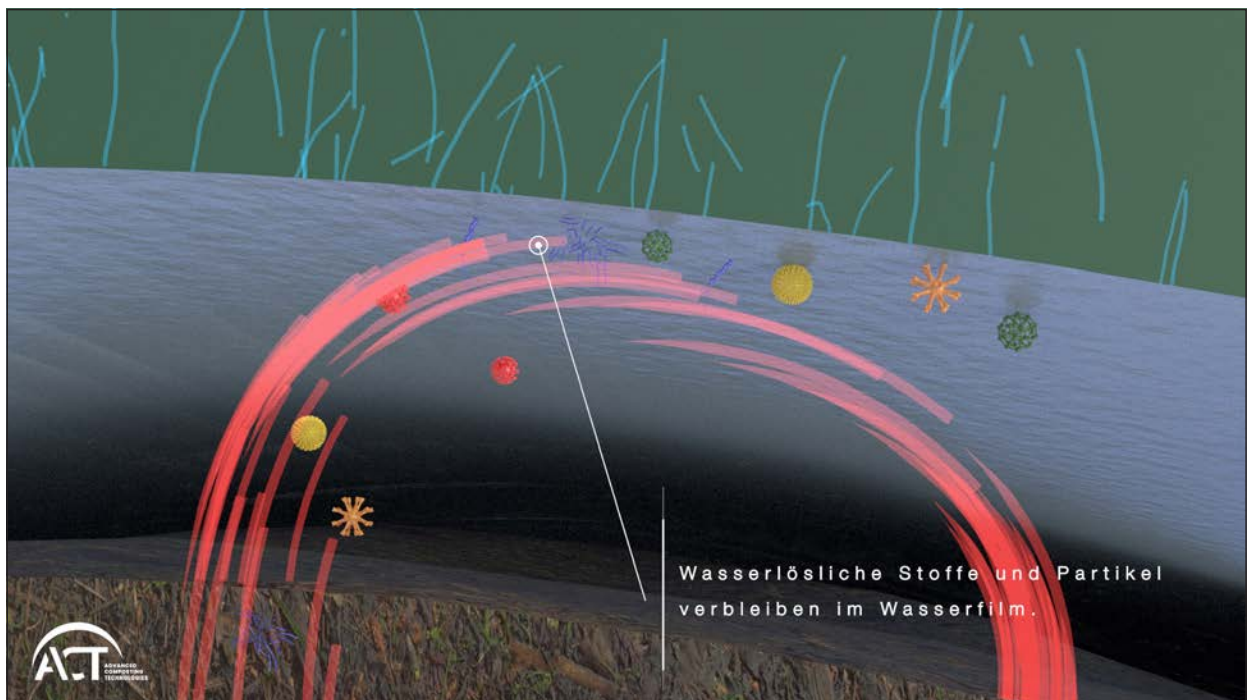

Bild 15

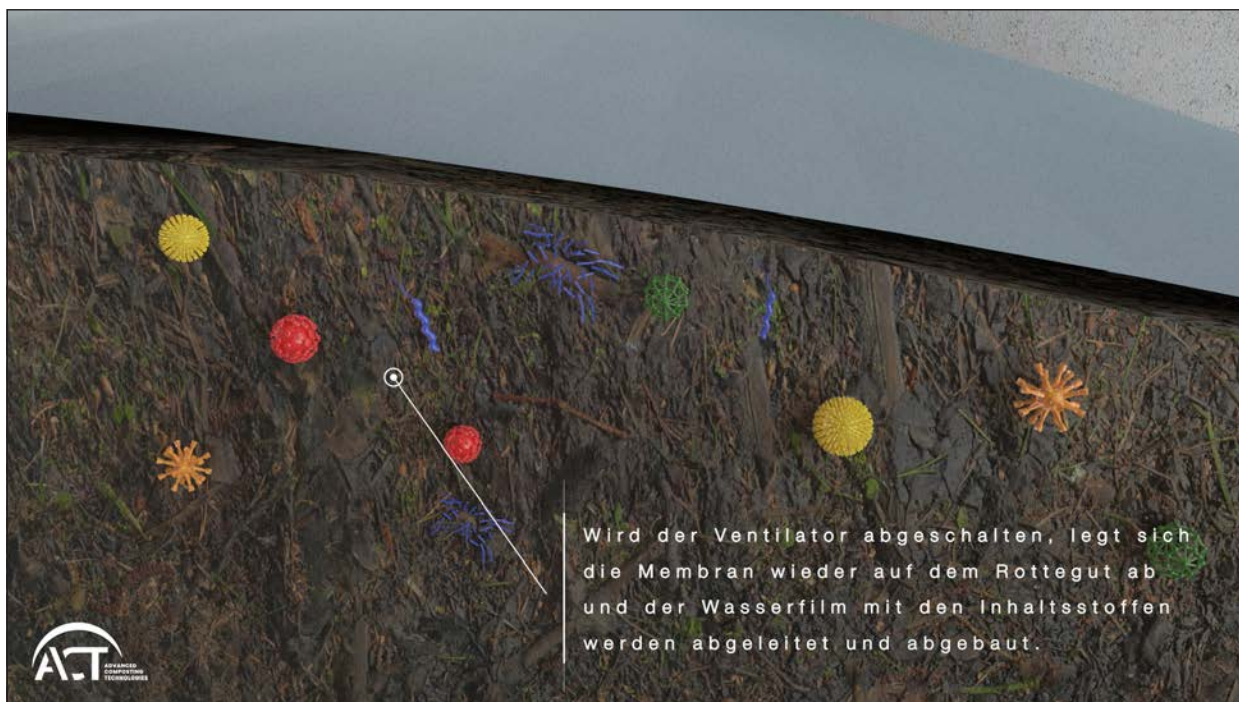

Bild 16

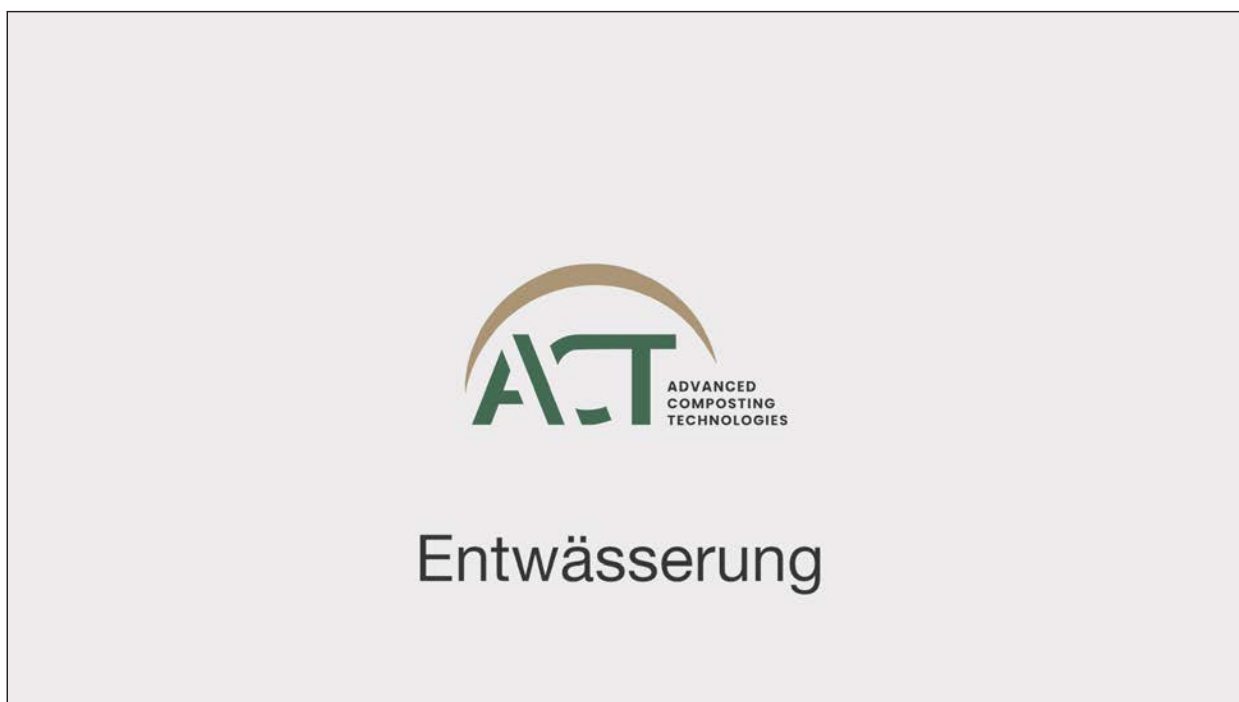

Bild 17

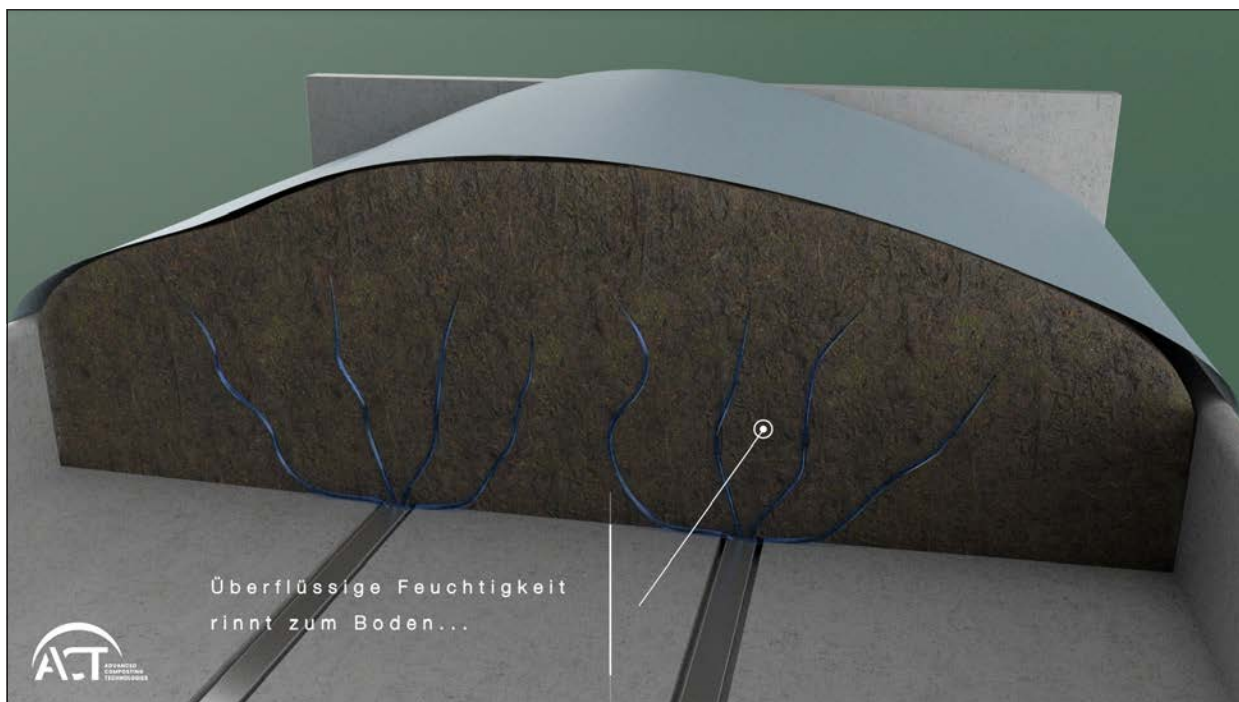

Bild 18



Bild 19

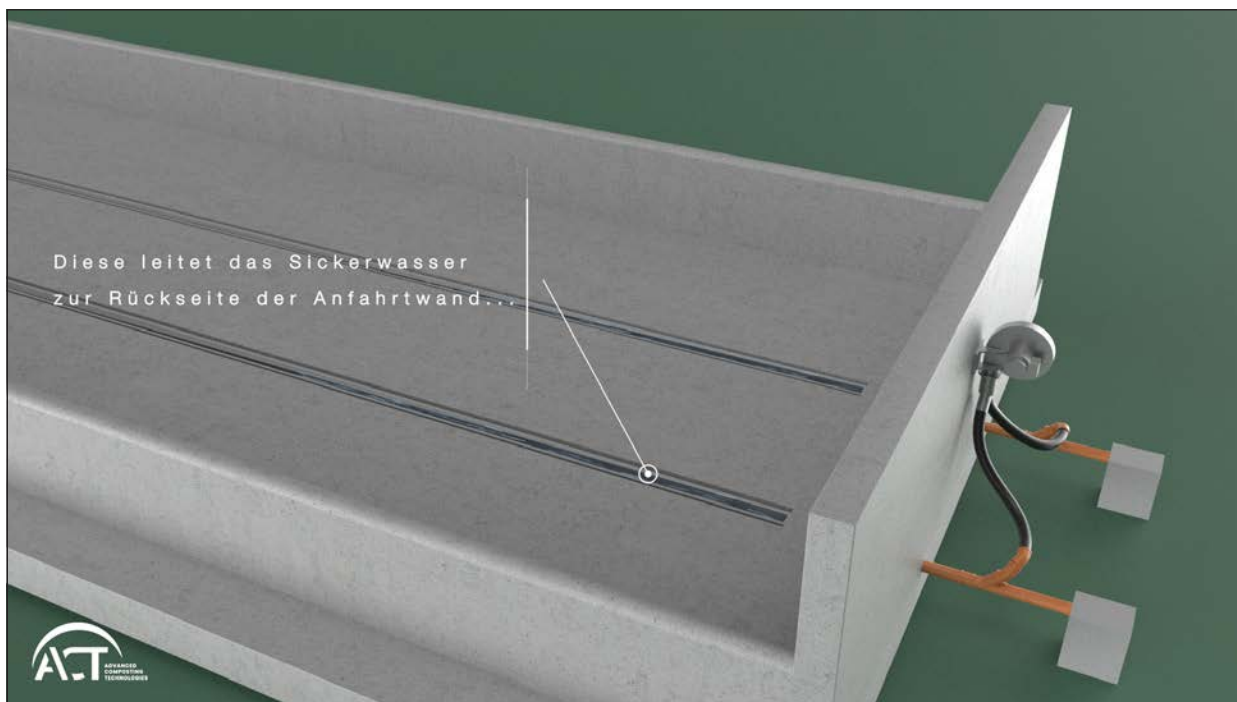
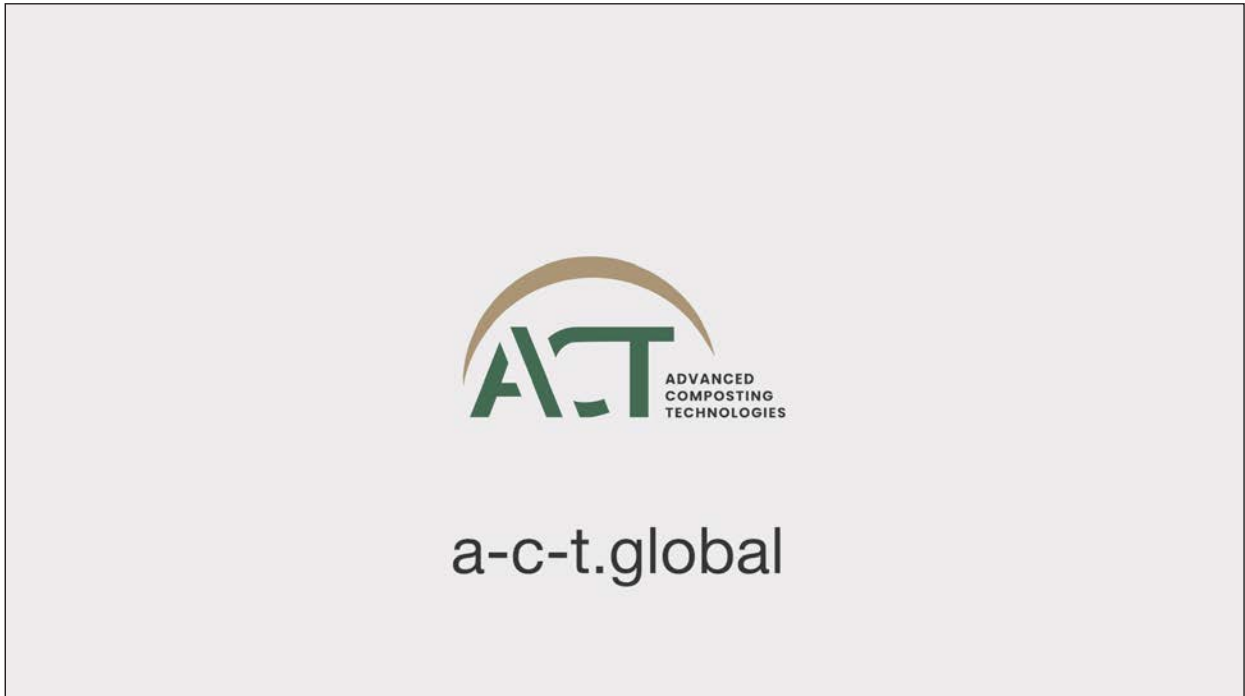

Bild 20